

# Plate Stainless (Slot 6 mm)

**SLP-2020**

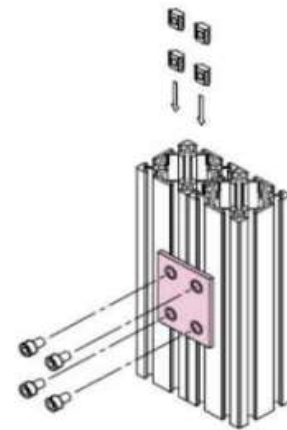

**SLP-2020L**

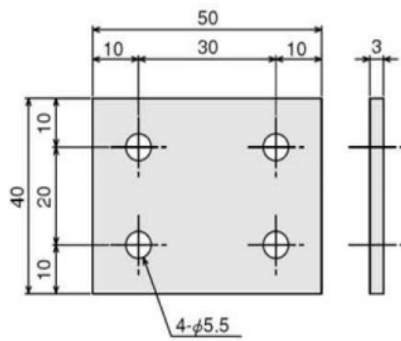
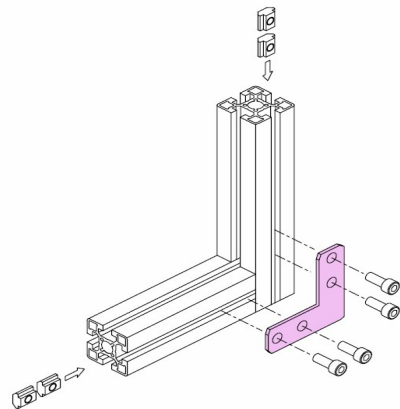
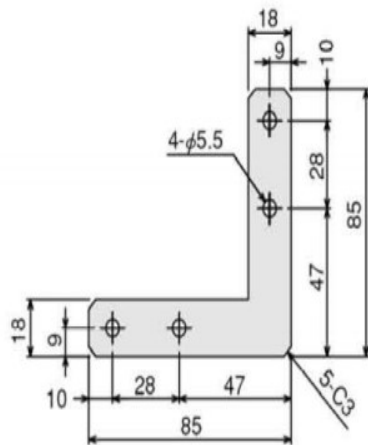

**SLP-2020T**

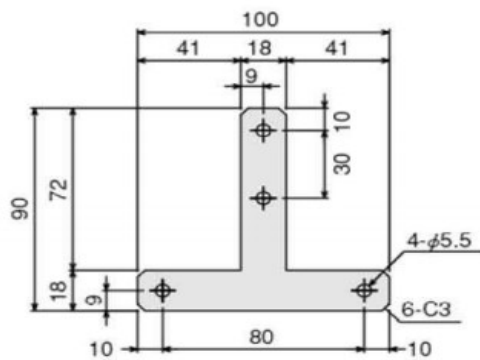
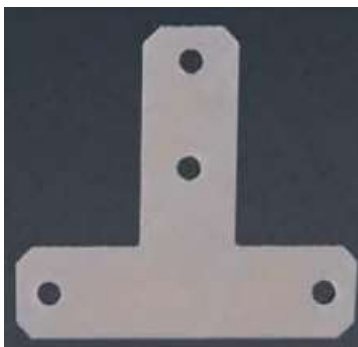

**SLP-2020+**

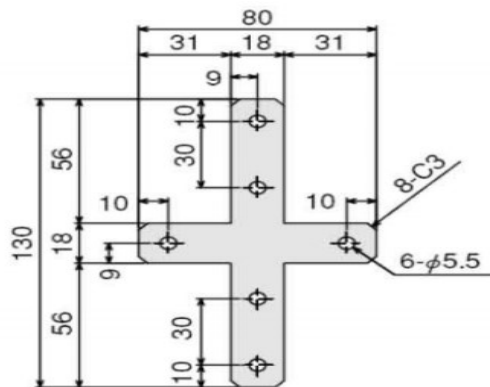
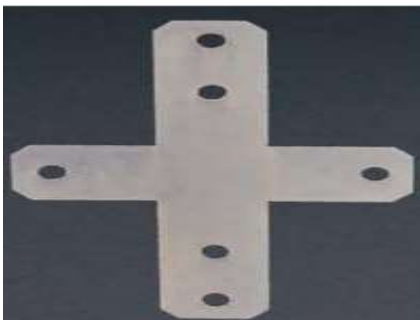

# Plate Stainless (Slot 6 mm)

**SLP-2020H4**

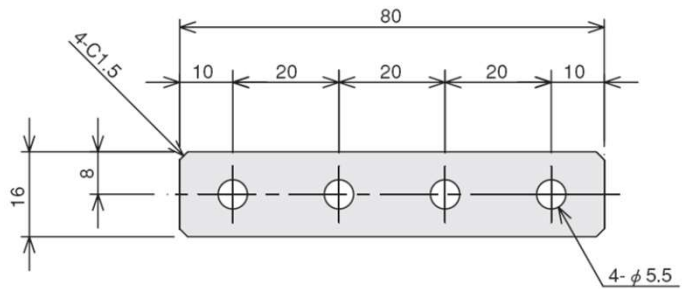

**SLP-2020H2**

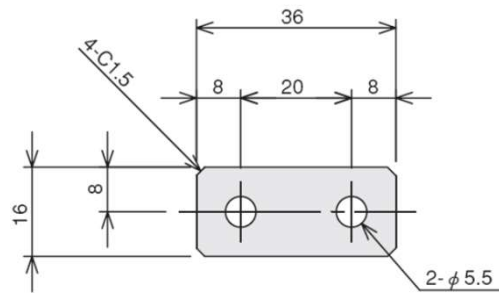

**CSLP-2020**

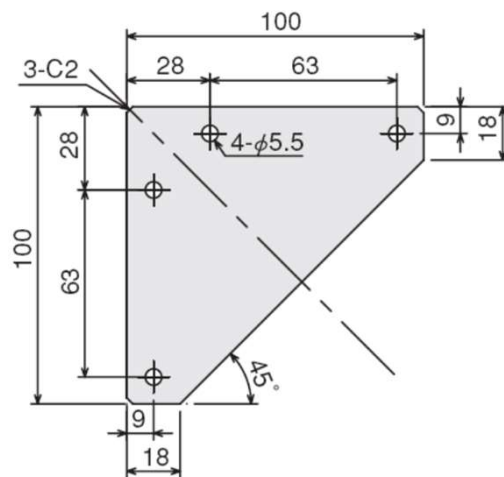

# Plate Stainless Slot 6 mm

**SLP-5560**

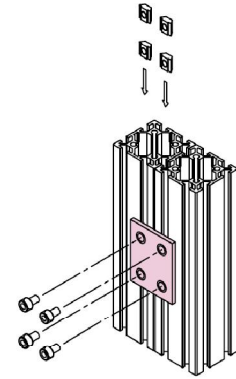
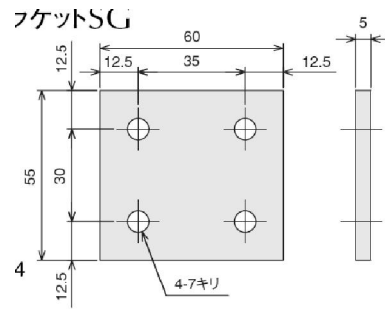
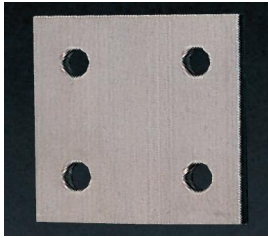

**SLP-8585L**

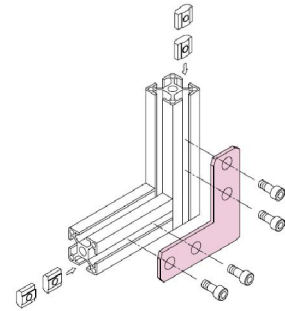
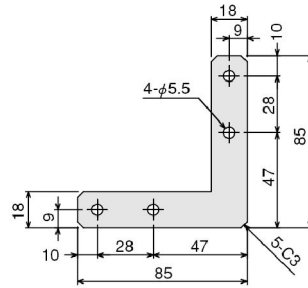
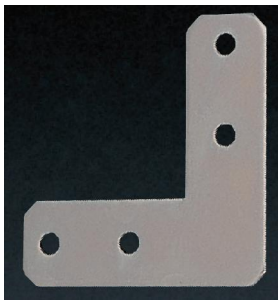

**CSLP-80130+**

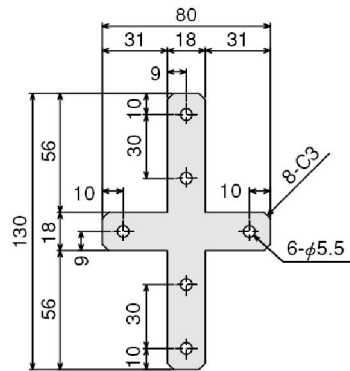
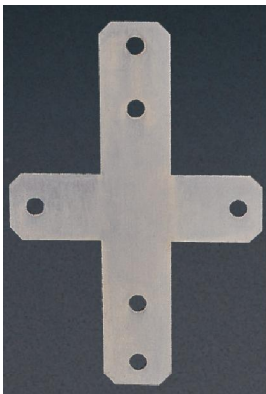

**SLP-90100 T**

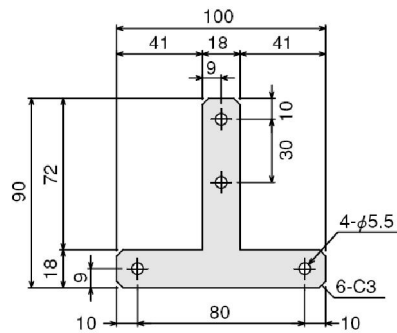
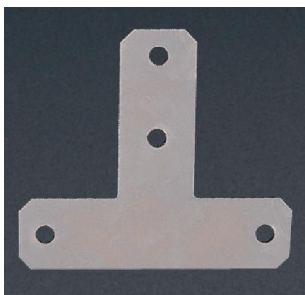

# Plate Stainless Slot 10 mm

**SLP-7585**

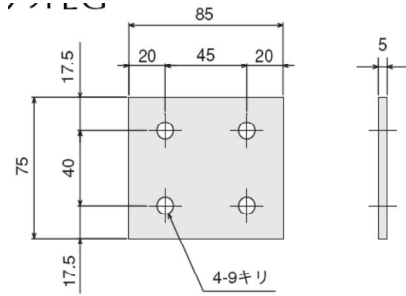
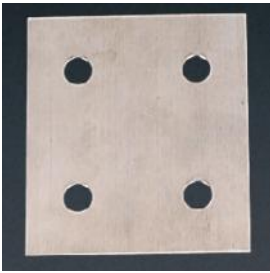

**SLP-8585L**

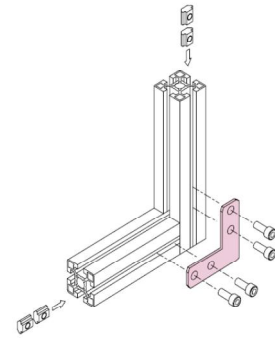
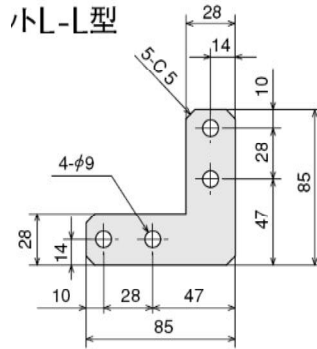

**SLP-90100T**

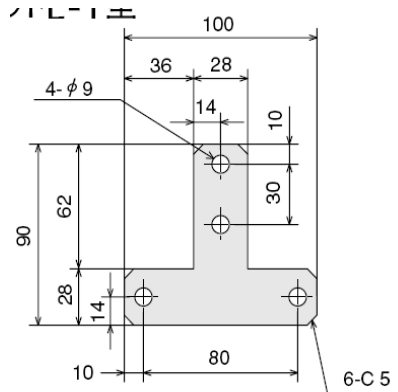
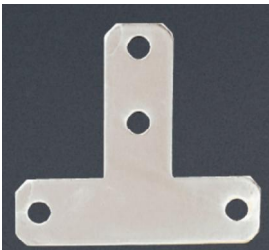

**SLP-100150**

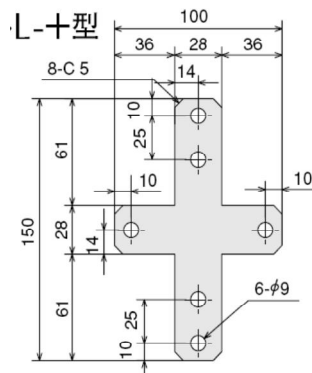

# Plate Stainless Slot 10 mm

**SLP-150150**

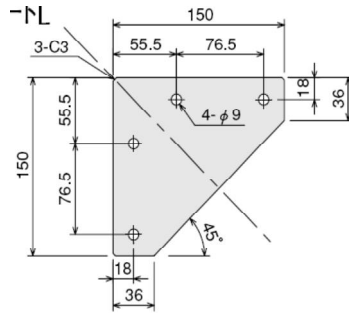
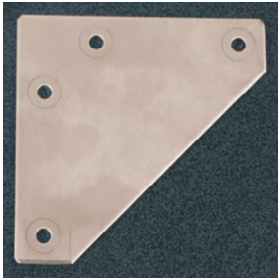

**SLP-15534**

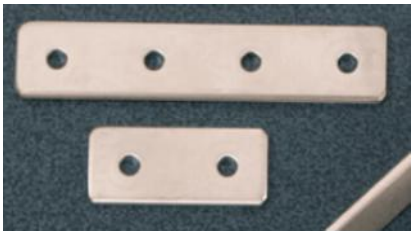

トノノケツL4U-H4

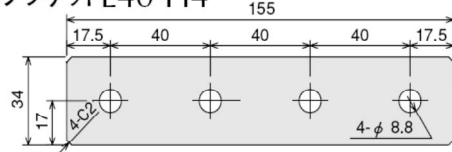

トブラケットL45-H4

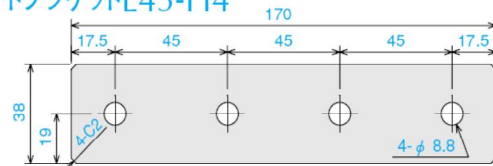

質量/11C

**SLP-7534**

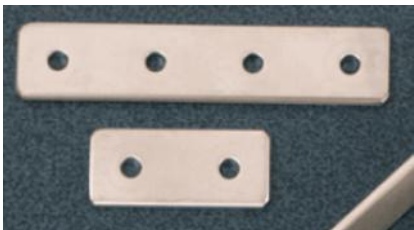

トノノケツL4U-H4

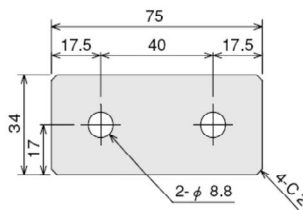

質量/11C

